

Accuphase

STEREO POWER AMPLIFIER

A-20

- Pure Class A operation delivers quality power : 20watts \times 2 into 8 ohms
- Power MOS-FET output stage features 3-parallel push-pull configuration
- Current feedback circuit topology ensures operation stability
- Bridged mode allows use as a monaural amplifier
- Balanced inputs
- Heavy-duty speaker terminals



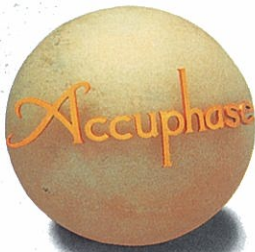

Pure Class A lets the sound emerge with sparkling clarity, like spring water from a deep well. Sound that still carries the ambience of silence. The output stage uses power MOS-FET devices arranged in a triple parallel configuration for each channel. Current feedback topology assures stability and creates an utterly natural sound stage. Perfectly suited also for use as midrange/high-range amplifier in a multi-amplification system.

The A-20 is a stereo power amplifier operating in pure class A. It incorporates a wealth of sophisticated Accuphase high-end technology. Each circuit device used in the A-20 has been strictly selected to provide top-grade performance. Its conservative power rating combined with unsurpassed musical realism make the A-20 ideal for use as a stand-alone amplifier in a highly efficient, quality-oriented system or as a midrange/high-range amplifier in a multi-amplification setup.

In pure class A operation, the power supply delivers a steady current, regardless of the presence or absence of a musical signal. This means that the amplifier remains unaffected by fluctuations in voltage and other external influences, allowing it to reproduce even the most demanding dynamics and delicate musical nuances with full fidelity. On the other hand, it also means that the output stage generates considerable thermal energy. The A-20 therefore uses power MOS-FET devices which have negative thermal characteristics and remain totally stable even under demanding operating conditions. In each channel, three of these devices are configured in a push-pull arrangement and mounted on massive heat sinks which provide ample capacity to dissipate the heat produced by the internal circuitry. Since the output stage remains linear with any load, the amplifier delivers full output power even when driving low-impedance speakers. When higher power levels are desired, it is also possible to use the A-20 in bridged mode as a monaural power amplifier.

An important feature of the A-20 is its use of current feedback circuit topology which virtually eliminates phase shifts in the upper frequency range. This principle also assures uniform frequency response which does not change with gain. In other words, it combines total operation stability with excellent frequency response. Thanks to this principle, phase compensation can be kept at a minimum, and high amounts of negative feedback with their associated disadvantages are no longer required. Transient response is excellent, with su-

perb sonic transparency and detail. This is the reason why music reproduced with the A-20 sounds breathtakingly real.

To make optimum use of the current feedback principle, the A-20 uses a gain control that also adjusts the degree of negative feedback. When gain is turned down, the noise threshold is further reduced, which is advantageous for example when the A-20 is operating as the midrange/high-range unit in a multi-amplification system where noise could otherwise become a problem.

The driving energy delivered by an amplifier to the speakers ultimately derives from its power supply. In the A-20, a transformer with a capacity of a 400 VA is used in combination with two 47,000µ F capacitors. This results in a wide performance margin and almost limitless current reserves. All signal-carrying copper traces on the printed circuit boards, as well as the input jacks, speaker terminals and other important parts are gold-plated, to assure utmost signal purity.

Output stage with power MOS-FETs in 3-parallel push-pull configuration and modular construction delivers linear power: 80 watts/ch into 2 ohms, 40 watts/ch into 4 ohms, 20 watts/ch into 8 ohms

Figure 1 shows the output stage of the A-20 which uses three parallel MOS-FET devices in each channel, mounted to large heat sinks. Output rating per channel is 80 watts into 2 ohms, 40 watts into 4 ohms, and 20 watts into 8 ohms. This linear progression shows that the amplifier is capable of driving even low-impedance loads with perfect stability.

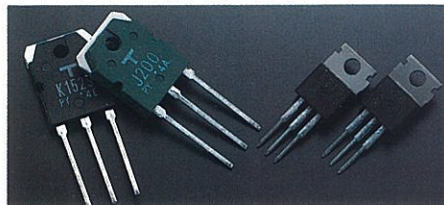

Power MOS FETs in driver stage and output stage

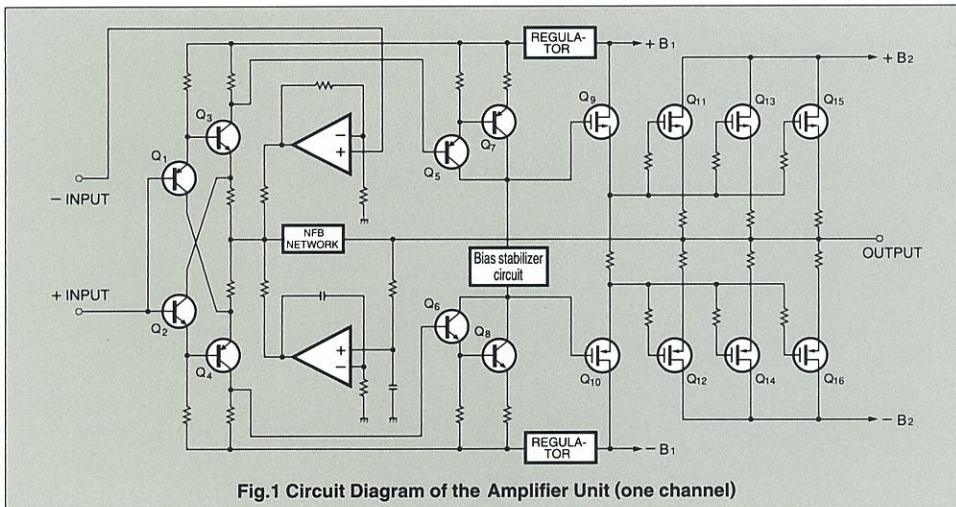

Fig.1 Circuit Diagram of the Amplifier Unit (one channel)

The parallel connection ensures that individual characteristics of the circuit devices, such as output impedance and inherent noise are balanced and kept to an absolute minimum. It also distributes the thermal energy evenly and makes optimum use of the excellent inherent linearity of MOS-FETs in the low-power range. The overall result of this approach is perfect operating stability combined with superb musicality.

In order to prevent occasional transients in the musical signal from causing undue clipping, the maximum clipping level has been set to 50 watts (8 ohms).

Current feedback circuit topology prevents phase shifts

The open-loop gain of an amplifying circuit decreases at higher frequencies. Conversely, when the gain is increased, frequency response, i.e. the bandwidth that can be handled by the amplifier, becomes more narrow. To counter this effect, a commonly employed technique called negative feedback (NFB) routes part of the output signal back to the input. If phase shift is disregarded, a circuit designed to have high open-loop-gain can apply a high amount of NFB, resulting in the wide frequency response of a closed-loop circuit, as shown in Figure 2.

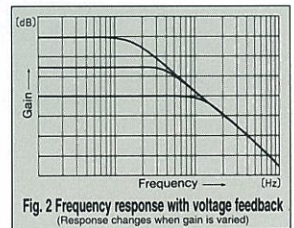

Conventional amplifiers employ voltage NFB, whereby the output voltage is used for the feedback loop. In the A-20 however, the signal current rather than the voltage is used for feedback. Figure 3 shows the operating principle of this circuit.

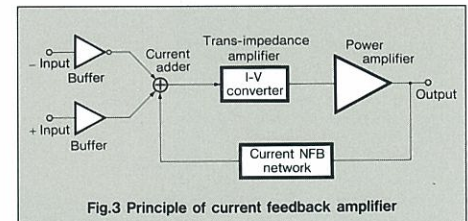

At the sensing point of the feedback loop, the impedance is kept low and current detection is performed. An impedance-converting amplifier then converts the current into a voltage to be used as the feedback signal. Since the impedance at the current feedback point (current adder in Fig. 3) is very low, there is almost no phase shift. Phase compensation can be kept to a minimum, resulting in excellent tran-

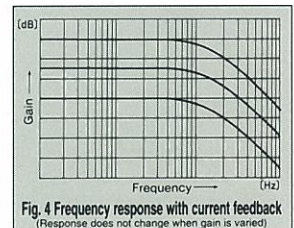

sient response and superb sonic transparency. Figure 4 shows frequency response for different gain settings of the current feedback amplifier. The graphs demonstrate that response remains uniform over a wide range.

NF switching type gain control minimizes residual noise

Since the use of current feedback results in stable operation with correct phase relationships, it has become possible to design a gain control which controls the amount of negative feedback. When amplifier gain is diminished, residual noise also becomes lower. This is especially welcome when driving highly efficient midrange speakers and tweeters in a multi-amplification system.



Bridged operation mode creates a true monophonic amplifier with 160 watts into 4 ohms or 80 watts into 8 ohms

Bridged mode means that the two channels of an amplifier are driven with the same signal voltage but with opposite phase, and their output is combined. The A-20 provides a switch arrangement for bridged operation, which turns the unit into a high-grade monaural amplifier capable of delivering a full 160 watts into 8 ohms or 80 watts into 4 ohms. Simply by adding another A-20 to form a stereo amplifier pair, a considerable further improvement in sonic performance can be realized.



Balanced connection reliably blocks induced noise
As illustrated by Figure 5, balanced signal trans-

mission means that the output stage of a component supplies two signal lines which have identical voltage but opposite phase. On the input side, these signals are fed to a positive and negative amplifier circuit and then mixed. Since any noise interference that has arisen during transmission will be present in both lines with identical phase, such noise

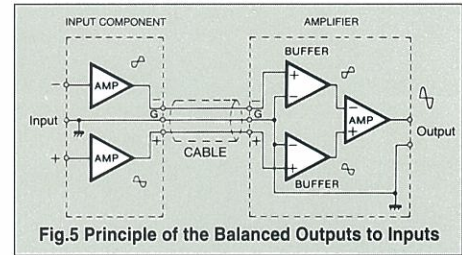

is canceled out when mixed in the input amplifier, leaving only the pure original signal. The balanced connection principle keeps the signal transfer completely free from any kind of interference.

Gold-plated PCB traces

High-purity copper is commonly used in audio components for signal path lines. The A-20 goes one

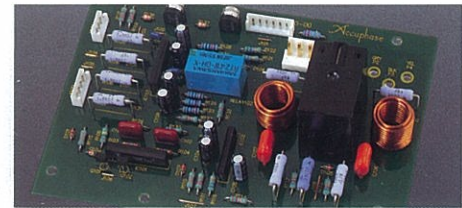

High-current output relays and protection circuit assembly

Large heat sinks with attached 3-parallel push-pull output stage and Current feedback amplifier unit



step further by providing gold-plating for printed circuit board traces as well as for the input jacks and speaker terminals. This approach results in a distinct sonic improvement.



Gold-plated RCA-type jacks and balanced connectors for input

Robust power supply with large power transformer and high filtering capacity

In a class A amplifier, the power supply plays a vital role since it must act as a constant current source at all times.



The A-20 therefore employs a large 400 VA power transformer housed in an enclosure filled with vibration-damping material. Two electrolytic capacitors, specially selected for their sonic properties and each rated for 47,000 μ F, provide ample filtering capacity for the rectified current. The capacitors feature an elastic soft coating which helps to make them impervious against the detrimental influence of vibrations.



Large, direct-reading peak power meters

The large analog power meters have a peak hold function which lets the user easily monitor the output level of the rapidly fluctuating music signal. Thanks to logarithmic compression, the meters cover a wide dynamic range. Switches for gain selection and illumination control are also provided.

Heavy-duty speaker terminals accommodate also banana plugs

The oversize speaker terminals accept even very heavy-gauge speaker cable, and it is also possible to insert banana plugs. The terminals are made of high-purity brass material finished by turnery process and gold-plated for utmost reliability and minimum contact resistance. Molded caps are provided to assure proper insulation.

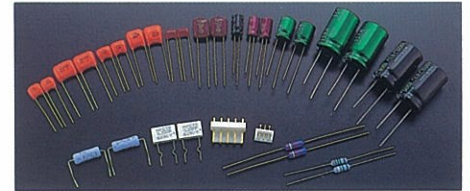

High-quality parts selected for outstanding sonic properties

FRONT PANEL

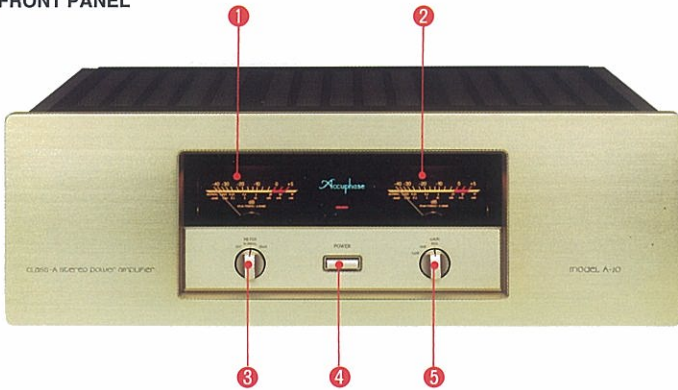

REAR PANEL

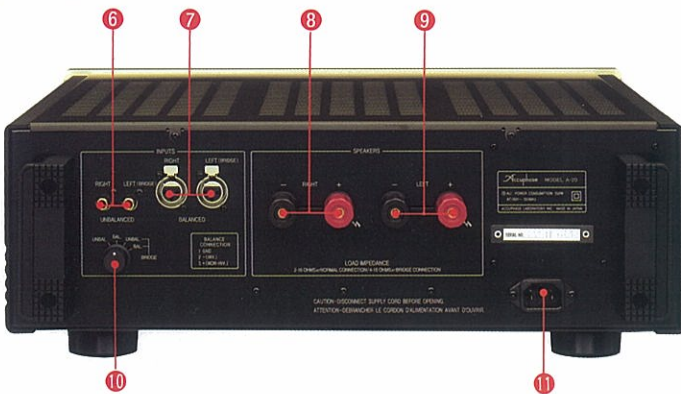

- | | |
|---|--|
| 1 Left channel output meter (dB div., wattage direct reading) | 6 Unbalanced input jack |
| 2 Right channel output meter | 7 (Balanced) input connectors. |
| 3 Meter operation and sensitivity switch OFF NORMAL -20dB | (1)Ground, (2) Inverted (-), (3) Non-inverted(+) |
| 4 Power switch | 8 Right channel output terminals speaker systems |
| 5 Gain selector Max -6dB -12dB | 9 Left channel output terminals speaker systems |
| | 10 Input/bridge selector UNBAL. BAL. BRIDGE UNBAL. BRIDGE BAL. |
| | 11 AC connector (for supplied power cord)* |

Remarks
* The shape of the supplied power cord depends on the voltage rating and destination country.

※ Specifications and design subject to change without notice for improvements.

GUARANTEED SPECIFICATIONS

Guaranteed specifications are measured according to EIA standard RS-490.
Performance Guaranty
All Accuphase product specifications are guaranteed as stated.

- **Continuous Average Output Power (20-20,000 Hz)**

Stereo mode(both channels driven)	80 watts per channel into 2-ohm load
	40 watts per channel into 4-ohm load
	20 watts per channel into 8-ohm load
Monophonic mode(bridging connection)	160 watts into 4-ohm load
	80 watts into 8-ohm load
- **Total Harmonic Distortion**

Stereo mode(both channels driven)	0.05%, with 2-ohm load
	0.02%, with 4 to 16 ohms load
Monophonic mode(bridging connection)	0.02%, with 4 to 16 ohms load
- **Intermodulation Distortion** 0.003%
- **Frequency Response** 20 to 20,000 Hz, +0 dB, -0.2 dB (Continuous average output power)
0.5 to 160,000 Hz, +0 dB, -3.0 dB (for 1 watt output, level control at maximum)
- **Gain (with GAIN selector in MAX position)** 28.0 dB (in stereo and monophonic mode)
- **Output Load Impedance** 2 to 16 ohms stereo mode
4 to 16 ohms in monophonic mode(bridging connection)
- **Damping Factor** 120 in stereo mode
60 in monophonic mode (bridging connection)
- **Input Sensitivity (with 8-ohm load)**

Stereo mode	0.50V(Continuous average output power)
	0.11V (for 1 watt output)
Monophonic mode(bridging connection)	1.00V(Continuous average output power)
	0.11V(for 1 watt output)
- **Input Impedance**

Balanced	: 40 k ohms
Unbalanced	: 20 k ohms
- **Signal-to-Noise Ratio (A-weighted)** 110 dB (input short circuit, Continuous average output power)
- **Power Level Meter**

Logarithmic compression type	
NORMAL	: -40dB to +5 dB and direct watt reading
-20 dB	: -60dB to -15 dB and direct watt reading
- **Power Requirements** 100V (Voltage as indicated on rear panel)AC, 50/60 Hz
- **Power Consumption** 160 watts at zero signal input
250 watts in accordance with IEC-65
- **Maximum Outline Dimensions** 475mm (18-11/16 inches) width,
170mm (6-11/16 inches) height,
427mm (16-13/16 inches) depth
- **Weight** 21.6kg (47.6lbs.)net
26.6kg (58.6lbs.)in shipping carton